



Wind Energy Solutions



Introduction

Carraro Group

Carraro is a multinational Group and world leader in power transmission systems. Its core business consists in conceiving, designing, validating, manufacturing and marketing drive systems for construction equipment, agricultural tractors, material handling, light commercial vehicles, automobiles, renewable energies and stationary applications (such as escalators and wind generators).

The Group, whose holding company Carraro Spa has been listed on the Italian Stock Exchange since 1995, is based in Campodarsego (Padua) and has manufacturing facilities in Italy, Germany, Argentina, the United States, India and China.

The Group Business Areas

CARRARO DRIVETECH

Integrated solutions (axles, transmissions, final & swing drives) for a wide range of applications: mining, construction equipment, agricultural tractors, light commercial vehicles, material handling and stationary applications (such as escalators & wind energy generators).

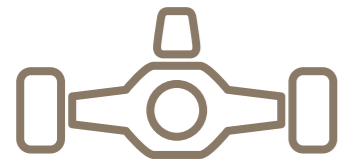

GearWorld

A Carraro Group Company

Low & high diameter steel gears, sinterized components and gears for earth-moving machines, agricultural tractors, cars, light commercial vehicles, two-wheel vehicles, power tools, garden equipment, railway and industrial applications, in particular for wind and solar energy.

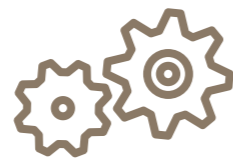

CARRARO AGRITALIA

Design and manufacturing of standard, vineyard & orchard tractors, from 50 to 100 HP; offering a wide range of engineering services, from simple consultancy to “turnkey” projects.

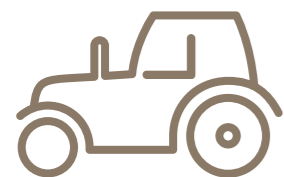

SANTERNO

CARRARO GROUP





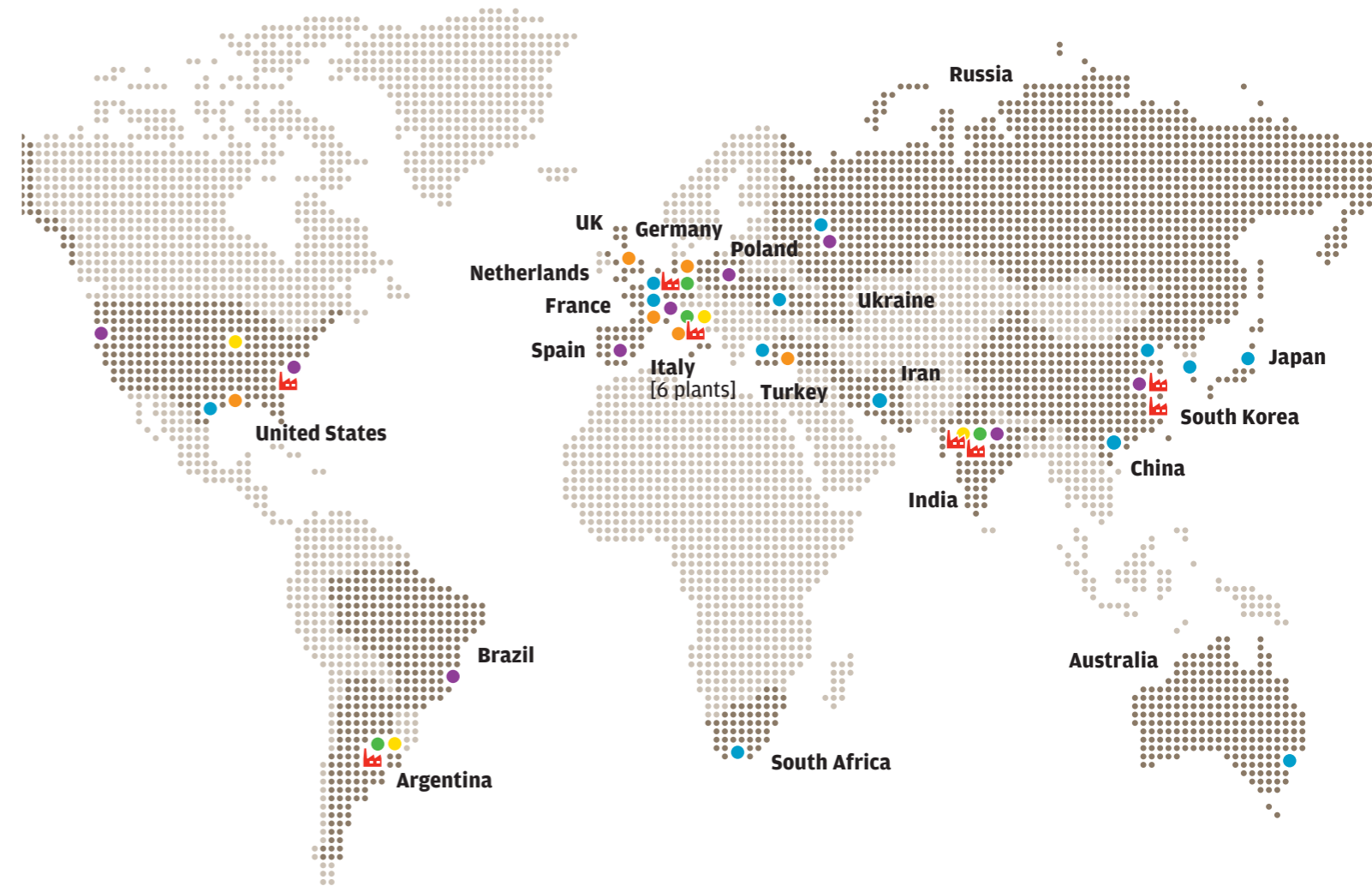

Inverters and power control, frequency converters, applied electronics for industrial plants, automation, renewable energies management (photovoltaic & wind energy), hybrid and electric vehicle powertrains.



Global footprint Where we are



HIGHLIGHTS

-  Manufacturing sites
-  Sales Offices
-  Engineering & Innovation Centers
-  Dealers
-  Service providers
-  Logistics & Spare Parts Centers

Wind Energy Solutions

Package for Wind Turbine Power Generation

Carraro, in line with its mission, focuses on highly efficient and eco-compatible products. Hence the attention towards renewable energy sources and the development of mechanical and electronic solutions for the future to be greener.

More in detail, concerning wind generators, the Group offers integrated solutions composed by:

- › Pitch & Yaw Drives
- › Main Inverters

This is possible thanks to our centre of excellence for heavy duty mechanical components in Germany, O&K Antriebstechnik, and to Santerno, our company focused on power electronics.

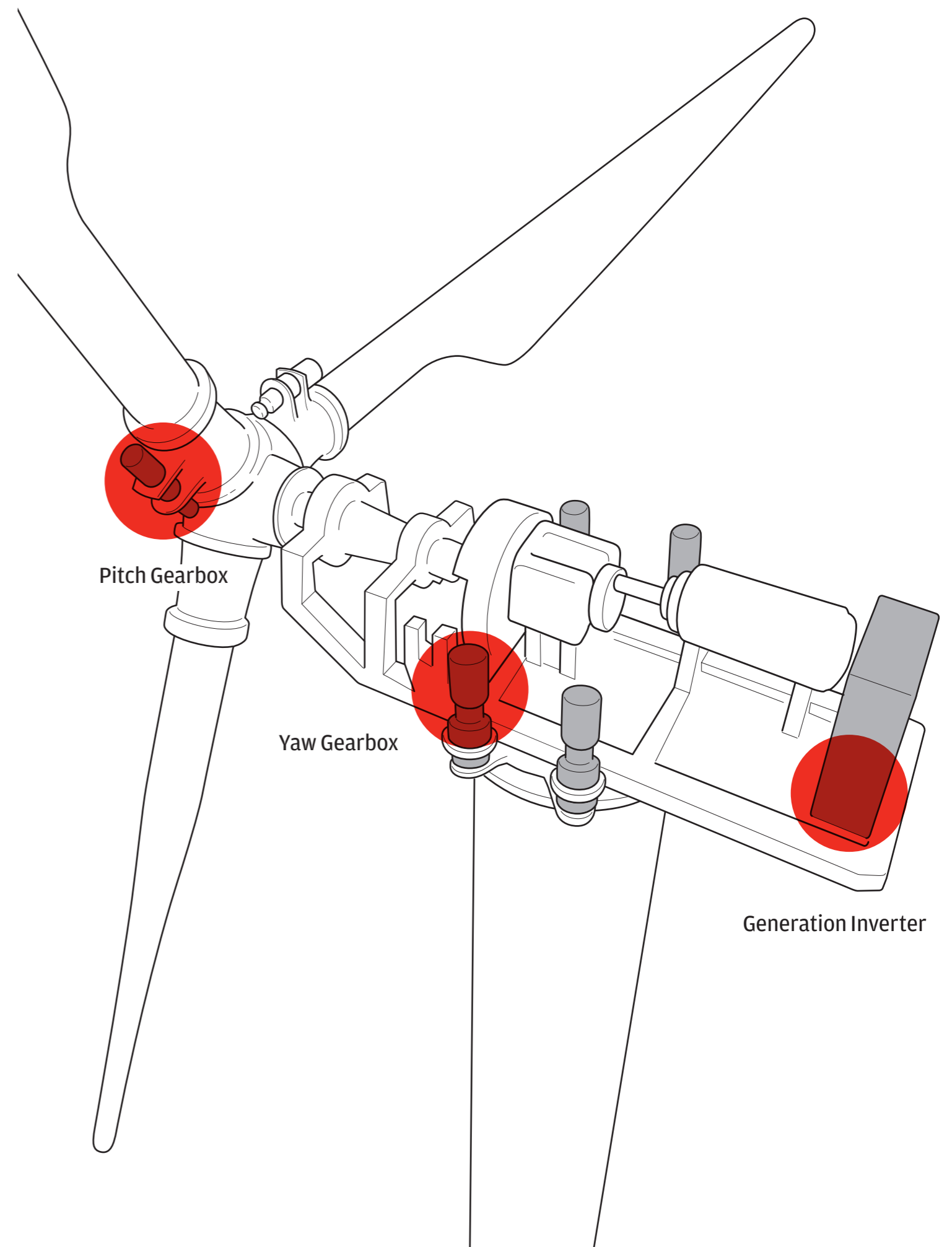

Wind Energy Solutions

Pitch and Yaw Drives

From 0.5 to 10 MW Nominal Power

Pitch Drives

Wind Generator / Nominal Power

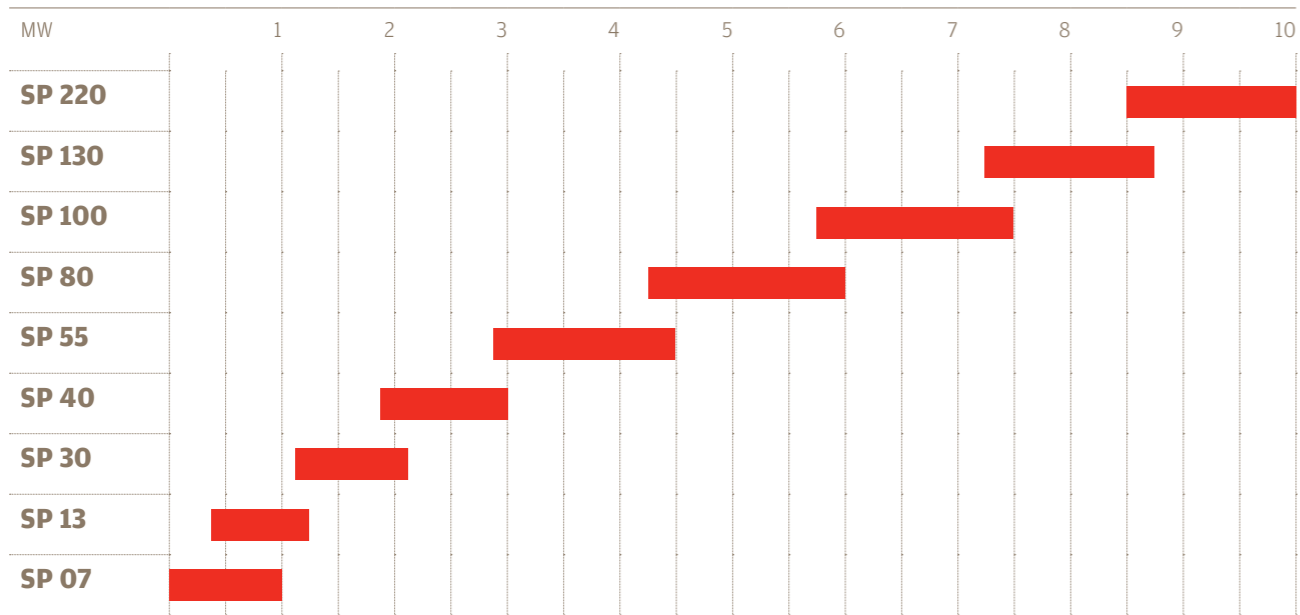

Yaw Drives

Wind Generator / Nominal Power

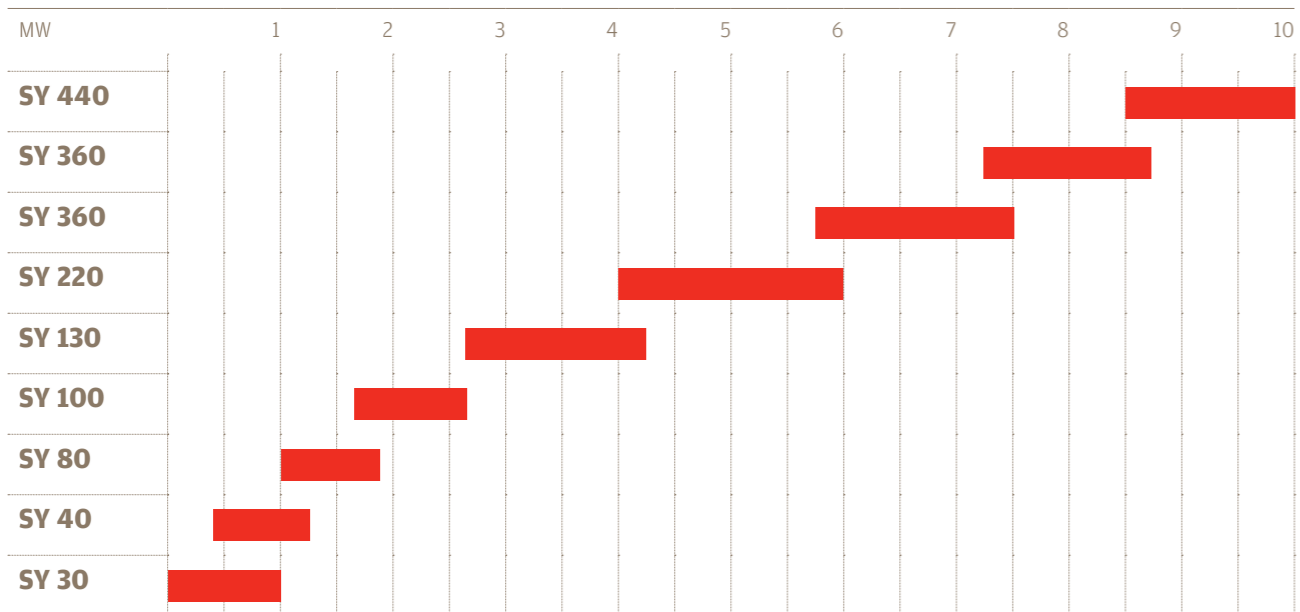

Main Inverters

From 0.4 kW to 5 MW

Main Inverters

Wind Generator / Nominal Power

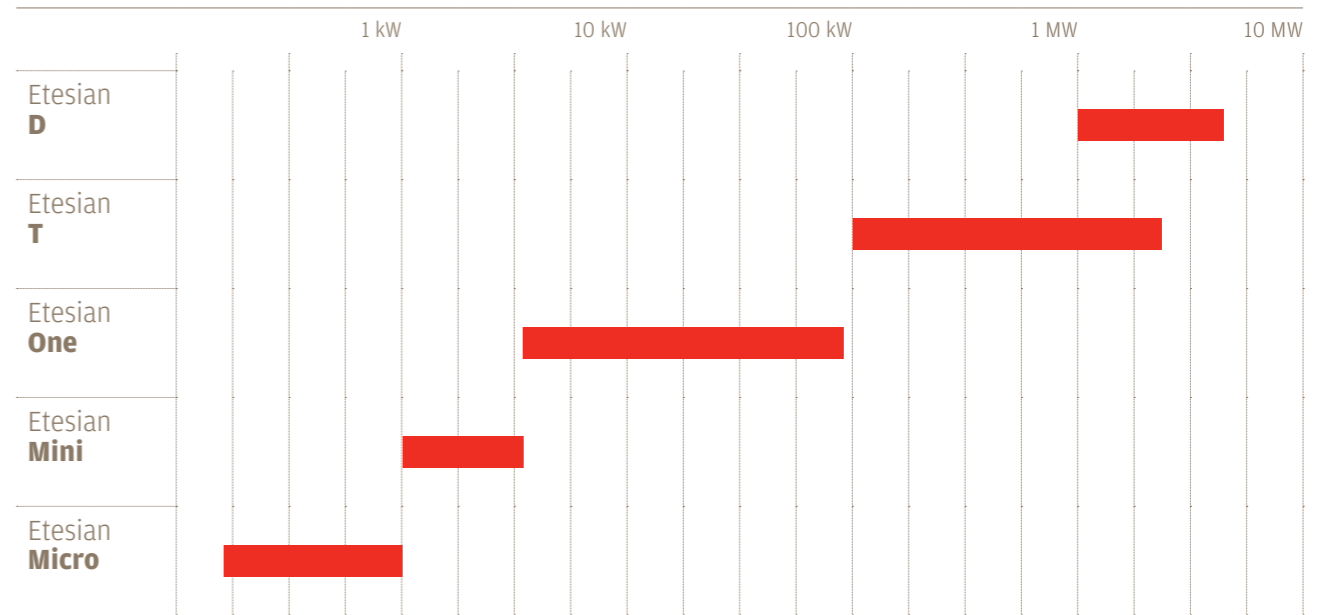

Pitch & Yaw Drives

Pitch Drives

Requirements & concept

- › Coverage of Generator Power Classes 500 KW - 10,000 KW
- › Ratios: 20 ... 2,500
- › Motor / Motor-connection optional depending on application
- › Planetary stages: 2 - 3
- › Planetary stages modular from existing O&K - F - Drive range
- › Standard and Long Support version variable housing

Output pinions optional depending on application

Key Features

- › High quality design
- › Extremely high reliability
- › Tailor made solution available
- › Different pinions configuration available
- › Compact dimensions

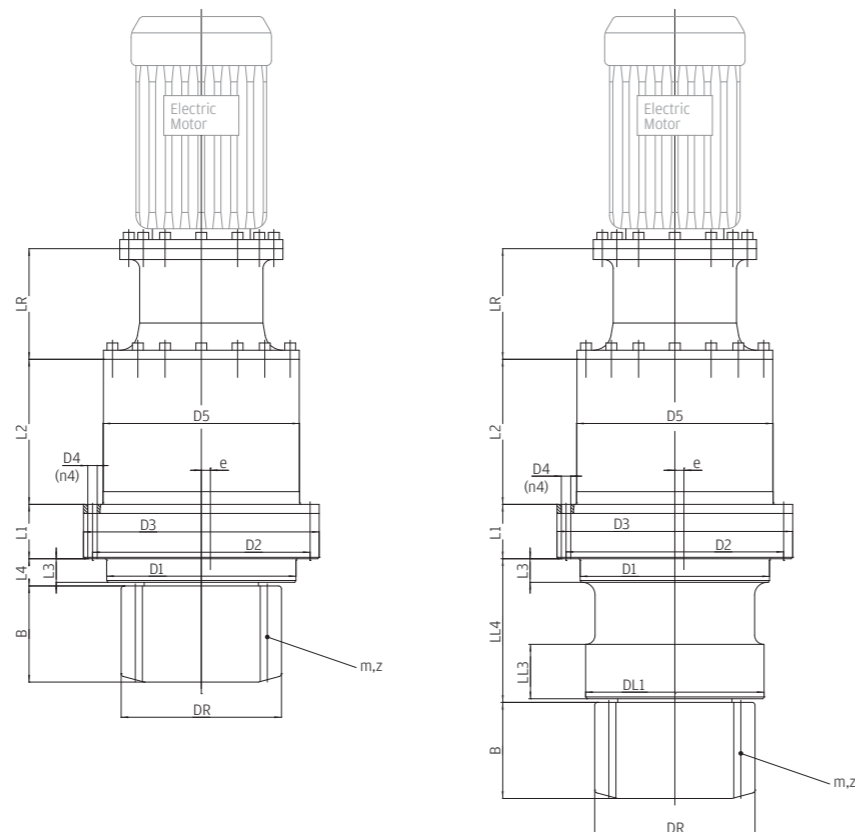

Standard version

Long Support version

SP		07	13	30	40	55	80	100	130	220
Static output torque	KNm	7	13	30	40	55	80	100	130	220
Nominal output torque	KNm	3.5	7.5	15	20	27.5	40	50	65	110
Ratio	(-)	63.5	22-250	20-250	20-250	23-250	20-250	23-250	23-250	26-2,500
Planetary stages	(-)	2	2-3	2-3	2-3	2-3	2-3	2-3	2-3	2-3

OUTPUT PINION ^[1]

Module m	mm	8	8	12	14	16	18	20	22	24
Number of teeth z		12	14	14	14	14	14	14	14	14
Tip circle diameter DR	mm	117.5	136	204	238	272	306	340	374	408
Width B	mm	90	82	120	142	162	180	200	220	186

DIMENSIONS

L1	mm	23	102	144	99	143	158	165	170	60
L2	mm	135	120	164	185	220	223	204	232.5	380
L3	mm	17	31	36	50	55	60	60	60	50
LL3 (Long Support)	mm	53	65	75	95	95	105	110	120	60
L4 (Standard)	mm	n.a.	40	46	54	62	68	69	70	150
LL4 (Long Support)	mm	162	[3]	[3]	[3]	[3]	[3]	[3]	[3]	[3]
LR	mm	63	[2]	[2]	[2]	[2]	[2]	[2]	[2]	[2]
D1	mm	160	195	250	275	330	380	388	430	520
DL1 (Long Support)	mm	150	190	245	270	320	370	380	420	510
D2	mm	220	260	305	335	400	450	460	500	585
D3	mm	250	290	335	370	435	490	500	550	630
D4	mm	18	17.5	17.5	17.5	22	25	26	26	26
n4	mm	4	8	18	20	20	20	24	32	24
D5	mm	185	220	270	295	350	400	408	450	524
e	mm	0.5	0.5	1	1	1	1.5	1.5	1.5	2
Electric Motor		[4]	[4]	[4]	[4]	[4]	[4]	[4]	[4]	[4]

[1] Alternative pinions on request

[2] LR = variable length depending on ratio / number of planetary stages

[3] LL4 = variable length depending on request

[4] Electric Motor and motor connection depending on request

Yaw Drives

Requirements & concept

- › Coverage of Generator Power Classes 500 KW - 10,000 KW
- › Ratios: 20 ... 2,500
- › Motor / Motor-connection optional depending on application
- › Planetary stages: 2 - 5
- › Planetary stages modular from existing O&K - F - Drive range
- › Standard and Long Support version variable housing

Output pinions optional depending on application

Key Features

- › High quality design
- › Extremely high reliability
- › Tailor made solution available
- › Different pinions configuration available
- › Compact dimensions

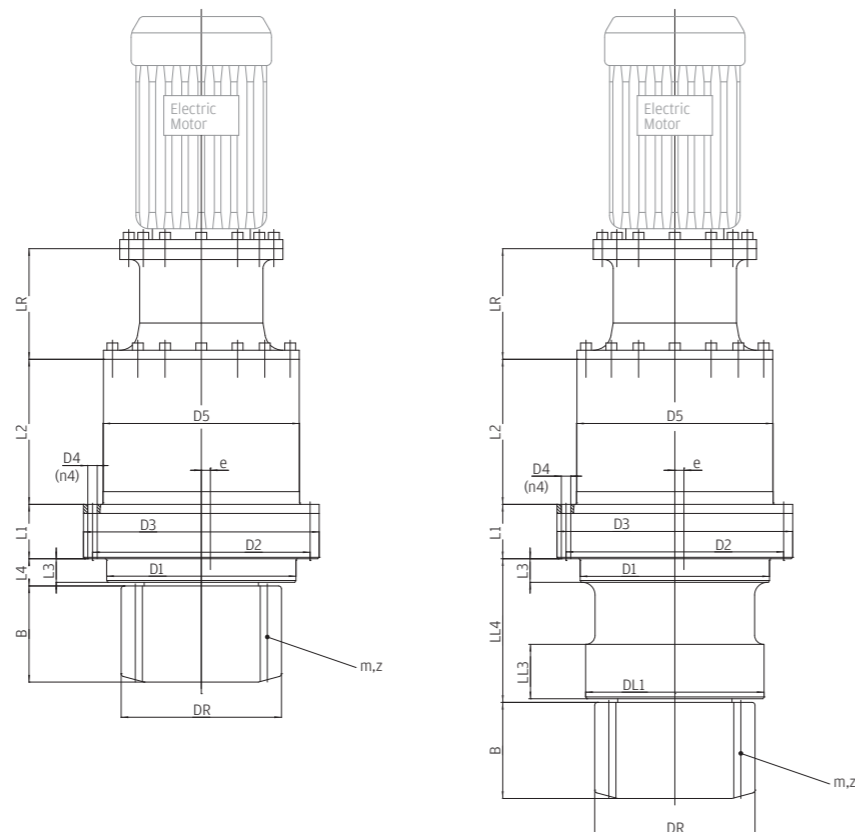

Standard version

Long Support version

SY		30	35	40	55	80	100	130	220	360	440
Static output torque	KNm	30	35	40	55	80	100	130	220	360	440
Nominal output torque	KNm	15	16.7	20	27.5	40	50	65	110	180	220
Ratio	(-)	20-2,500	1,433	20-2,500	23-2,500	20-2,500	23-2,500	23-2,500	26-2,500	26-2,500	26-2,500
Planetary stages	(-)	2-5	4	2-5	2-5	2-5	2-5	2-5	2-5	2-5	2-5

OUTPUT PINION ^[1]

Module m	mm	12	12	14	16	18	20	22	24	26	30
Number of teeth z		14	15	14	14	14	14	14	14	14	14
Tip circle diameter DR	mm	204	213	238	272	306	340	374	408	440	508
Width B	mm	120	97	142	162	180	200	220	186	186	280

DIMENSIONS

L1	mm	144	34	99	143	158	165	170	60	80	80
L2	mm	164	120	185	220	223	204	232.5	380	520	680
L3	mm	36	10	50	55	60	60	60	50	50	50
LL3 (Long Support)	mm	75	75	95	95	105	110	120	60	70	80
L4 (Standard)	mm	46	n.a.	54	62	68	69	70	150	155	165
LL4 (Long Support)	mm	[3]	245	[3]	[3]	[3]	[3]	[3]	[3]	[3]	[3]
LR	mm	[2]	115	[2]	[2]	[2]	[2]	[2]	[2]	[2]	[2]
D1	mm	250	270	275	330	380	388	430	520	560	630
DL1 (Long Support)	mm	245	230	270	320	370	380	420	510	550	600
D2	mm	305	315	335	400	450	460	500	585	680	730
D3	mm	335	355	370	435	490	500	550	630	775	800
D4	mm	17.5	17.5	17.5	22	25	26	26	26	32	32
n4	mm	18	20	20	20	20	24	32	24	30	30
D5	mm	270	275	295	350	400	408	450	524	650	715
e	mm	1	1	1	1	1.5	1.5	1.5	2	2	2.5
Electric Motor		[4]	[4]	[4]	[4]	[4]	[4]	[4]	[4]	[4]	[4]

[1] Alternative pinions on request

[2] LR = variable length depending on ratio / number of planetary stages

[3] LL4 = variable length depending on request

[4] Electric Motor and motor connection depending on request

Main Inverters

Etesian Micro

Single Phase Inverter for Wind Turbines

Key Features

- › Freely configurable power curve related to turbine PM generator speed
- › Sensorless vector control of the generator current internal braking unit internal crowbar circuit for over speed protection
- › True sine-wave output grid-current
- › Grid guard: automatic disconnection in accordance with CEI 11-20, ENEL DK5940, DIN VDE0126-1-1 “ENS”
- › Power factor 1 output
- › 5-year warranty
- › IP65 complete system
- › Top efficiency
- › USB Computer interface



	400		1000	
Turbine adjustment	Polynomial curve, 16 points			
Rated power of the turbine	400 W		1,000 W	
Wind generator	Three-phase PM			
SMPS switching voltage	100 Vdc			
	rpm/Hz	Open-circuit Vrms	rpm/Hz	Open-circuit Vrms
Speed rate/Minimum operating voltage	20/5	70	20/5	70
Speed rate/Maximum operating voltage	6,000/150	240	6,000/150	240
Maximum input voltage	300		300	
Crowbar trip voltage	Programmable	Can be factory-set	Programmable	Can be factory-set
Minimum voltage ensuring rated power	160 Vac			
Maximum input frequency	150 Hz		150 Hz	
Rated inverter input current	1.8		4.5	
Maximum inverter input current	2		5	
Rated grid voltage	230 Vac			
Grid voltage variation	+/- 20%			
Rated inverter output current	1.8		4.5	
Maximum inverter output current	2		5	
Grid current distortion	4% with max. 2% grid distortion			
Rated grid frequency	50-60 Hz			
Power factor	1			
Overtoltage category	III			
Maximum efficiency/ European efficiency	92%/91%		93%/92%	
Temperature range	-20 +60°C, derating starting from 40°C			
Humidity	100 %			
Maximum altitude	3,000 asl			
Limitation of DC-Bus voltage and maximum speed	By means of braking chopper			
Braking chopper current (A)	2		5	
Overspeed safety device	Generator short-circuit by way of: - Safety relay controlling an external shunt opening release - Crowbar circuit operating independently of the microprocessor control			
Maximum short circuit current of the generator (phase Irms) (A)	6			
Self-consumption on stand-by	1 W			

The rated values ensure continuous operation of the inverter under the above-mentioned environmental requirements. The maximum values are the values limiting the inverter quantities.

Etesian Mini

Single Phase Inverter for Wind Turbines

Key Features

- › Freely configurable power curve (32 points) related to turbine PM generator speed
- › Maximum operating voltage range (24-550 Vdc)
- › True sine-wave output grid-current
- › Grid guard: automatic disconnection in accordance with CEI 11-20, ENEL DK5940
- › Grid guard: DIN VDE 0126-1-1 ENS (optional)
- › Galvanic isolation from grid by means of integrated transformer
- › Power factor 1 output
- › 5-year warranty (20 years optional)
- › IP54/IP65 complete system
- › Top efficiency
- › Optional wind interface box, with AC/DC rectifier and braking control
- › Optional datalogging and environmental measure acquisition and storage

		2600	3600	4300	5300	6400	7800
Nominal AC power	W	2,000	2,750	3,300	4,100	4,900	6,000
Max AC power	W	2,200	3,000	3,600	4,500	5,400	6,600
Max input current	A	15	15	15	15	15	15
Input voltage range	Vdc	24 ÷ 550	24 ÷ 550	24 ÷ 550	24 ÷ 550	24 ÷ 550	24 ÷ 550
Output voltage	Vac	230 +/- 15%	230 +/- 15%	230 +/- 15%	230 +/- 15%	230 +/- 15%	230 +/- 15%
Output frequency	Hz	50 or 60	50 or 60	50 or 60	50 or 60	50 or 60	50 or 60
Grid power factor	cosφ	1	1	1	1	1	1
Total AC current distortion		< 3%	< 3%	< 3%	< 3%	< 3%	< 3%
Safety varistors		yes	yes	yes	yes	yes	yes
Protection degree		IP 65	IP 65	IP 65	IP 54	IP 54	IP 54
Dimensions	mm	L 290 H 710 D 220	L 290 H 710 D 220	L 290 H 710 D 220	L 290 H 710 D 220	L 290 H 710 D 220	L 290 H 710 D 220
Operating temperature range	°C	-25 ÷ +60	-25 ÷ +60	-25 ÷ +60	-25 ÷ +60	-25 ÷ +60	-25 ÷ +60



Etesian One

Three Phase Inverter for PGM Wind Turbines

Key Features

- › Maximum operating voltage range
- › Freely configurable power curve (32 points) related to turbine PM generator speed
- › True sin-wave output grid-current
- › Grid guard: automatic disconnection in accordance with CEI 11-20, and Guida per le connessioni alla rete elettrica di Enel Distribuzione, Ed. I - 1/213 (Guidelines for connections to the electrical grid from Enel, the Italian Electricity Board) (formerly ENEL DK5940)
- › Grid guard: DIN VDE 0126-1-1 ENS (optional)
- › Galvanic isolation from grid by means of integrated transformer
- › Power factor 1 output
- › 2-year warranty (20 years optional)
- › IP44 complete system
- › 400V and 800V version also available
- › Top efficiency

		14	19	26	42	61	90	110
INPUT RATINGS								
Max. DC input power	kW	12.4	16.7	23.2	37.7	54.4	79.5	98.2
Rated DC input power	kW	11.2	15.1	21.1	34.4	49.4	72.2	89.2
Max. input current	A(dc)	31.4	42.6	60.6	97.4	140.1	204.0	251.4
Input voltage range	Vdc	315 ÷ 630	315 ÷ 630	315 ÷ 630	315 ÷ 630	315 ÷ 630	315 ÷ 630	315 ÷ 630
Open-circuit voltage	Vdc	740	740	740	740	740	740	740
MAX DC INPUT VOLTAGE								
Max. output power	kW	11.7	15.9	22	36	51.8	75.6	93.2
Rated output power	kW	10.6	14.4	20.0	32.8	47.1	68.7	84.7
Rated output current	A(ac)	15.3	20.8	28.9	47.3	68.0	99.2	122.3
EFFICIENCY								
Efficiency		95.3%	96.0%	95.9%	96.1%	96.0%	95.9%	96.0%
MECHANICAL FEATURES								
Dimensions	mm	L 800 H 1616 D 600	L 800 H 1616 D 600	L 800 H 1616 D 600	L 800 H 1616 D 600	L 800 H 1616 D 600	L 800 H 1616 D 600	L 800 H 1616 D 600
Weight	Kg	260	280	340	450	518	785	827



Etesian T

Direct Drive Induction Generator Inverter

Key Features

- › Variable operating speed: 0 to 120% of nominal speed
- › Grid-tied drive to exchange power with the grid with Active Front End (sinusoidal current shape)
- › Optional Conformance to E-On grid code (LVRT and grid voltage support after event)
- › Wide Power Range up to 2,5MW (690Vac)
- › Inverter assisted start-up (optional)
- › Rugged construction with metal case (stainless steel version available)
- › Compact housing
- › Speed-Power curve can be embedded in the drive
- › Manageable reactive power on grid side
- › Control subsystem power supply form UPS: easy managements of grid faults (grid codes)
- › Direct interface with most used field busses (Modbus, Profibus, CAN-Open, etc)
- › Modular construction: easy and quick spare part service, common spare parts among different converter power sizes
- › Option: Water Cooled

		250	350	400	550	800	900	1100	1500	2500
Size		S65	S65	S65	S65	S65	S70	S80	S80	S85
Typical windfull power	Kw	250	350	400	550	800	900	1,100	1,500	2,500
Rated inverter power	Kw	460	570	750	950	1,200	1,400	2,000	2,300	3,300
Inverter rated current	A	390	480	630	800	1,000	1,200	1,700	1,950	2,850
Max. inverter current	A	480	600	720	960	1,300	1,440	2,040	2,340	3,400
Power curve		[1]	[1]	[1]	[1]	[1]	[1]	[1]	[1]	[1]
Grid voltage	Vrms	690 -/+ 10%	690 -/+ 10%	690 -/+ 10%	690 -/+ 10%	690 -/+ 10%	690 -/+ 10%	690 -/+ 10%	690 -/+ 10%	690 -/+ 10%
Grid frequency	Hz	50 or 60	50 or 60	50 or 60	50 or 60	50 or 60	50 or 60	50 or 60	50 or 60	50 or 60
Grid power factor	cosφ	1	1	1	1	1	1	1	1	1
Grid current harmonic distorsion		< 3%	< 3%	< 3%	< 3%	< 3%	< 3%	< 3%	< 3%	< 3%

[1] Torque speed parametric look-up table or external torque set-point



Etesian D

Double Fed Induction Generator Inverter

Key Features

- › Cost and size optimization without affecting performance
- › DFIG Inverter below 1/3 of the rated wind turbine power
- › Variable speed operations up to +/- 30% of synchronous speed
- › Rotor connected drive with DFIG Vector Control
- › Grid-tied drive to exchange power with the grid with Active Front End (sinusoidal current shape)
- › Optional Conformance to E-On grid code (LVRT and grid voltage support after event)
- › Wide Power Range up to 5MW (690Vac)
- › Rugged construction with metal case (stainless steel version available)
- › Compact housing
- › Speed-Power curve can be embedded into the drive
- › Manageable reactive power on grid side
- › Control subsystem power supply form UPS: easy managements of grid faults (grid codes)
- › Direct interface with most used field busses (Modbus, Profibus, CAN-Open, etc)
- › Option: Water Cooled

		1000	1300	1400	1500	2000	3000	3300	4200	5000
Size		S65	S65	S65	S65	S65	S65	S70	S80	S80
Typical Peak Wind power	Kw	1,000	1,300	1,400	1,500	2,000	3,000	3,300	4,200	5,000
Rated inverter power	Kw	460	570	650	750	950	1,200	1,400	2,000	2,300
Inverter DC rated current at "syn" speed	A	278	341	360	390	544	773	858	1,086	1,337
Inverter rated current	A	390	480	550	630	800	1,000	1,200	1,700	1,950
Max. inverter current		480	600	660	720	960	1,300	1,440	2,040	2,340
Power curve		[1]	[1]	[1]	[1]	[1]	[1]	[1]	[1]	[1]
Grid voltage	Vrms	690 -/+ 10%	690 -/+ 10%	690 -/+ 10%	690 -/+ 10%	690 -/+ 10%	690 -/+ 10%	690 -/+ 10%	690 -/+ 10%	690 -/+ 10%
Grid frequency	Hz	50 or 60	50 or 60	50 or 60	50 or 60	50 or 60	50 or 60	50 or 60	50 or 60	50 or 60
Grid power factor	cosφ	1	1	1	1	1	1	1	1	1
Grid current harmonic distorsion		< 3%	< 3%	< 3%	< 3%	< 3%	< 3%	< 3%	< 3%	< 3%

[1] Torque speed parametric look-up table or external torque set-point



The Power Transmission Excellence is our Passion

Carraro Spa Headquarters

Via Olmo, 37
35011 Campodarsego
(Padova), Italy
T +39 049 9219111
F +39 049 9289111
webinfo@carraro.com

O&K Antriebstechnik GmbH

Nierenhofer Str. 10
D-45525 Hattingen
Germany
T +49 2324 205 01
o&k@carraro.com

Elettronica Santerno Spa Headquarters

Strada Statale Selice, 47
40026 Imola
(Bologna), Italy
T +39 0542 489711
info@santerno.com
sales@santerno.com
www.santerno.com

Project related installation drawings
can be made available on request
as dimensions and technical data
are subject to change due
to continuous development.



carraro.com